

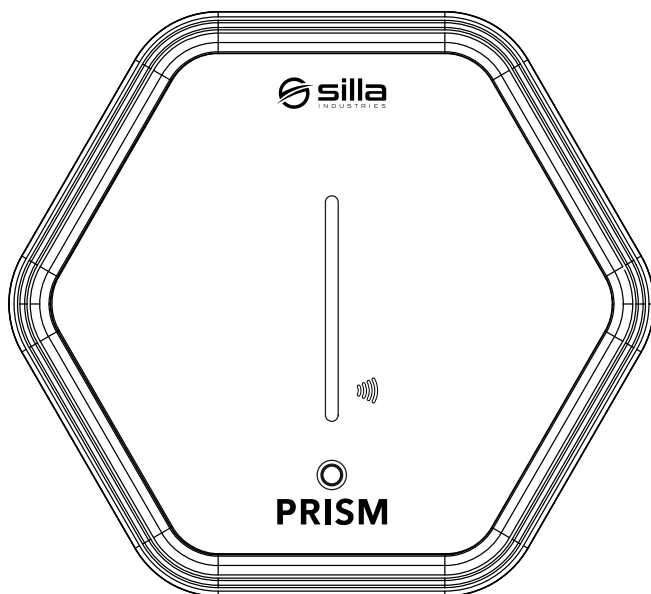

## Prism Solar

### Guida rapida d'installazione

Quick Setup Guide - Guide de configuration rapide



ONLINE <https://silla.industries/docs/>



# Index

---

<b>Avvertenze</b>	3
(EN) Warnings - (FR) Avertissements	
<b>Identificazione prodotto</b>	4
(EN) Product identification - (FR) Identification du produit	
<b>Luogo di montaggio</b>	5
(EN) Place of Assembly - (FR) Lieu d'assemblage	
<b>Attrezzi</b>	6
(EN) Tools - (FR) Outils	
<b>Imballaggio</b>	6
(EN) Packaging - (FR) Emballage	
<b>Dimensioni (mm)</b>	7
(EN) Dimensions (mm) - (FR) Dimensions (mm)	
<b>Montaggio</b>	8
(EN) Assembly - (FR) Montage	
<b>Installazione Prism Solar</b>	10
(EN) Prism Solar installation - (FR) Installation de Prism Solar	
<b>Prism Solar Monofase</b>	11
(EN) Prism Solar single-phase - (FR) Prism Solar Monophasé	
<b>Prism Solar Trifase</b>	13
(EN) Prism Solar Three-phase - (FR) Prism Solar Triphasé	
<b>Impianti con sistema di accumulo</b>	16
(EN) Systems with storage system - (FR) Dispositifs avec système d'accumulation	
<b>Bobina di sgancio</b>	19
(EN) Release coil - (FR) Bobine de déclenchement	
<b>Completare l'installazione</b>	19
(EN) Complete the installation - (FR) Terminer l'installation	
<b>Configurazione guidata</b>	21
(EN) Wizard setup - (FR) Assistant de configuration	
<b>Primo utilizzo</b>	22
(EN) First use - (FR) Première utilisation	
<b>Funzionalità</b>	22
(EN) Functionality - (FR) Fonctionnalité	
<b>Assistenza clienti</b>	24
(EN) Customer service - (FR) Nettoyage périodique	

<b>Garanzia</b>	25
<b>(EN)</b> Warranty - <b>(FR)</b> Garantie	
<b>Caratteristiche tecniche</b>	25
<b>(EN)</b> Technical features - <b>(FR)</b> Caractéristiques techniques	
<b>Dichiarazione di conformità UE</b>	25
<b>(EN)</b> EU Declaration of Conformity - <b>(FR)</b> Déclaration de Conformité de l'UE	

## Avvertenze

### (EN) Warnings - (FR) Avertissements



- (IT) Leggere il manuale prima di procedere  
(EN) Read the manual before proceeding  
(FR) Lire le manuel avant toute chose



- (IT) Rischio Elettrico  
(EN) Electric shock risk  
(FR) Risque électrique



- (IT) Rifiuto speciale - seguire le norme locali di smaltimento  
(EN) Special waste - follow local disposal regulations  
(FR) Déchets spéciaux - suivre les réglementations locales en matière d'élimination

### (IT) Obblighi



- Il dispositivo va protetto da un RCD almeno di tipo A e con corrente di intervento non superiore a 30 mA.
- Verificare e seguire le normative locali di installazione e sicurezza. L'installatore si assume la responsabilità di garantire il rispetto di tali norme.
- L'installazione, manutenzione e riparazione devono essere eseguite da personale qualificato.
- In caso di contraddizione tra il manuale e le normative locali, seguire sempre il requisito più rigoroso tra i due.
- Conservare il presente manuale.
- Seguire le procedure e condizioni d'uso descritte nel manuale.
- Sono consentiti solo accessori e adattatori forniti dal produttore.

### (IT) Rischi



- Non utilizzare il prodotto se aperto o danneggiato.
- In situazioni anomale, di funzionamento non corretto o danneggiamento durante l'uso spegnere il dispositivo e contattare l'assistenza.
- Possibili pericoli in caso di uso improprio. Il produttore non si assume responsabilità per danni derivanti da uso improprio.
- Verificare il connettore di ricarica prima dell'utilizzo, non utilizzarlo se sporco o danneggiato.
- Quando non utilizzato coprire sempre il connettore utilizzando il tappo di protezione o il porta-connettore adeguato.
- Mantenere sempre in ordine il cavo di ricarica per evitare pericoli di inciampo o ostruzione dei passaggi.
- Non è consentito l'uso di prolunghie.

### (EN) Obligations



- The device must be protected by a type A RCD and a tripping current not exceeding 30 mA.
- Check and follow local installation and safety regulations. The installer assumes responsibility for ensuring compliance with these standards.
- Installation, maintenance, and repairs must be carried out by qualified personnel.
- In case of contradiction between the manual and local regulations, always follow the stricter requirement of the two.
- Keep this manual.
- Follow the procedures and conditions described in the manual.
- Only accessories and adaptors supplied by the manufacturer are permitted.

### (EN) Risks



- Do not use the product if it is opened or damaged.
- In abnormal situations, incorrect operation, or damage during use, turn off the device and contact support.
- Possible dangers may occur in case of improper use. The manufacturer assumes no liability for damage resulting from improper use.
- Before use, verify the charging connector; do not use it if it is dirty or damaged.
- When not in use always cover the connector using the protective cap or the appropriate connector holder when not in use.
- Always keep the charging cable in order to avoid tripping hazards or obstructed passages.
- The use of extension cords is not permitted.

### (FR) Obligations



- L'appareil doit être protégé par un disjoncteur différentiel (RCD) de type A au minimum et dont le courant de déclenchement ne dépasse pas 30 mA.
- Vérifier et respecter les réglementations locales en matière d'installation et de sécurité. Le respect de ces normes relève de la responsabilité de l'installateur.
- L'installation, l'entretien et les réparations doivent être effectués par un personnel qualifié.
- En cas de contradiction entre le manuel et les réglementations locales, toujours suivre l'exigence la plus stricte des deux.
- Conservé ce manuel.
- Suivre les procédures et les conditions décrites dans le manuel.
- Seuls les accessoires et adaptateurs fournis par le fabricant sont autorisés.

### (FR) Risques



- Ne pas utiliser le produit s'il est ouvert ou endommagé.
- En cas de situation anormale, de fonctionnement incorrect ou de dommage pendant l'utilisation, éteindre l'appareil et contacter le service d'assistance.
- Dangers possibles en cas d'utilisation incorrecte. Le fabricant n'assume aucune responsabilité pour les dommages résultant d'une utilisation inappropriée.
- Pour vérifier le connecteur de charge avant utilisation, ne l'utilisez pas s'il est sale ou endommagé.
- Lorsqu'il n'est pas utilisé, recouvrez toujours le connecteur à l'aide du capuchon de protection ou du porte-connecteur approprié.
- Gardez toujours le câble de charge rangé de manière à éviter les risques de trébuchement ou les passages obstrués.
- L'utilisation de rallonges n'est pas autorisée.

## Identificazione prodotto

(EN) Product identification - (FR) Identification du produit

### ► Etichetta prodotto

(EN) Product label - (FR) Étiquette du produit

(IT) Etichetta esterna di Prism.

(EN) Label the Prism Exterior.

(FR) Étiquette extérieure de Prism.

(IT) Numero seriale

(EN) Serial number

(FR) Numéro de série

<b>Prism</b>	Silla srl Made in Italy	3 5	CE	
Product ID:	PBS03320205R			
Serial:	A01601			
Mfg. Date:	2021-12			
In:	32A AC@25°C 400V-50/60Hz 3L+N+PE			
Out:	32A AC@25°C 400V-50/60Hz 3L+N+PE 22kW max.			

### ► Etichetta credenziali

(EN) Credential label - (FR) Label d'identification

(IT) Utilizzare per configurazione di Prism.

(EN) Use for Prism configuration.

(FR) Utiliser pour la configuration de Prism.

Serial #:  
MAC:  
WiFi SSID:  
WiFi pwd:

username	password

(IT) Conservare e non condividere le credenziali.

(EN) Store and do not share credentials.

(FR) Sauvegarder et ne pas partager les informations d'identification.

## Luogo di montaggio

(EN) Place of Assembly - (FR) Lieu d'assemblage

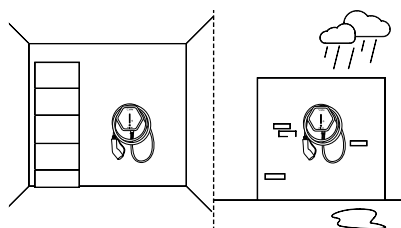

**1.**  
(IT) Installabile all'aperto. Consigliata installazione al coperto per minore sporcizia ed usura.

(EN) It can be installed outdoors. Recommended installation at covered for minor dirt and wear.

(FR) Peut être installé en extérieur. Il est recommandé de l'installer dans un endroit à l'abri pour moins des salissures et d'usure.

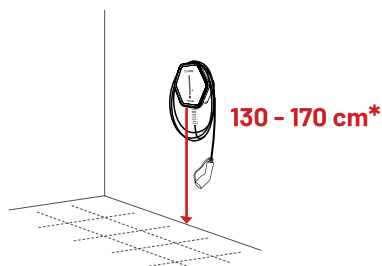

**2.**  
(IT) Altezza di montaggio consigliata.

(EN) Recommended mounting height.

(FR) Hauteur de montage recommandée.

(IT) \*Suggerimento - Verificare le normative nazionali per le altezze di installazione.

(EN) \*Tip - Check national regulations for installation heights.

(FR) \*Conseil - Vérifier les réglementations nationales pour les hauteurs d'installation.



## Avvertenze di montaggio

(EN) Assembly warnings - (FR) Avertissements relatifs à l'assemblage

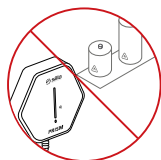

(IT) Non montare in prossimità di materiali infiammabili, esplosivi o combustibili, sostanze chimiche o solventi, tubi a gas o prese di vapore, radiatori o batterie.

(EN) Do not mount near flammable, explosive or combustible materials, chemicals or solvents, gas pipes or steam vents, radiators, or batteries.

(FR) Ne pas installer l'appareil à proximité de matériaux inflammables, explosifs ou combustibles, de produits chimiques ou de solvants, de conduites de gaz ou d'évents, de radiateurs ou de batteries.



(IT) Non montare in prossimità di aree soggette a fonti di calore o luce solare diretta.

(EN) Do not mount near areas subject to heat sources or direct sunlight.

(FR) Ne pas installer l'appareil à proximité de sources de chaleur ou de la lumière directe du soleil.

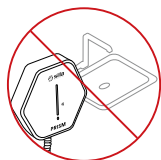

(IT) Non montare in prossimità di aree soggette ad allagamenti, umidità elevata o acqua corrente.

(EN) Do not mount near areas prone to flooding, high humidity, or running water.

(FR) Ne pas installer l'appareil à proximité de zones inondables, très humides ou avec de l'eau courante.

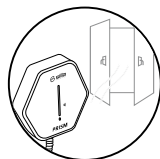

(IT) Garantire sufficiente ventilazione per evitare surriscaldamenti.

(EN) Ensure sufficient ventilation to avoid overheating.

(FR) Assurer une ventilation suffisante pour éviter la surchauffe.



## Attrezzi

(EN) Tools - (FR) Outils



(IT) Giravite a croce  
(EN) Phillips screwdriver  
(FR) Tournevis cruciforme



(IT) Trapano o avvitatore  
(EN) Drill or screwdriver  
(FR) Perceuse ou tournevis



(IT) Fresa conica  
(EN) Conical cutter  
(FR) Couteau conique

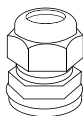

(IT) Pressacavo o pressatubo  
(EN) Cable gland or pipe clamp  
(FR) Presse-étoupe ou collier de serrage



∅ 6 mm

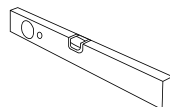

(IT) Bolla ad aria (consigliata)  
(EN) Air bubble (recommended)  
(FR) Niveau d'eau (recommandé)

## Imballaggio

(EN) Packaging - (FR) Emballage

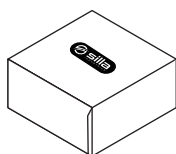

4X 12X

MONOFASE - SINGLE-PHASE - MONOPHASÉ

TRIFASE - THREE-PHASE - TRIPHASÉ

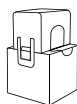

(IT) Sensore: 1 per monofase  
(EN) Sensor: 1 for single phase  
(FR) Capteur: 1 pour monophasé

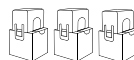

(IT) Smart meter, 3 sensori, ferrite  
(EN) Smart meter, 3 sensors, ferrite  
(FR) Smart Meter, 3 capteurs, ferrite



## Dimensioni (mm)

(EN) Dimensions (mm) - (FR) Dimensions (mm)

### Prism Solar

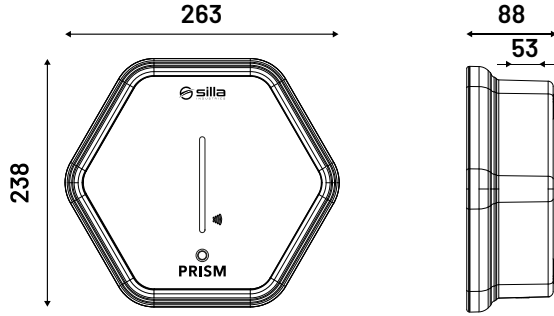

### Sensor

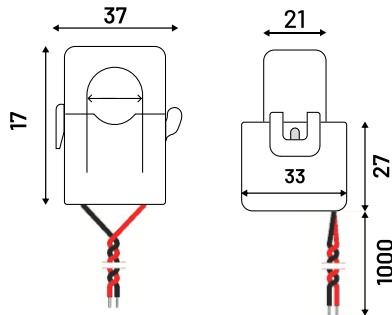

### Smart Meter

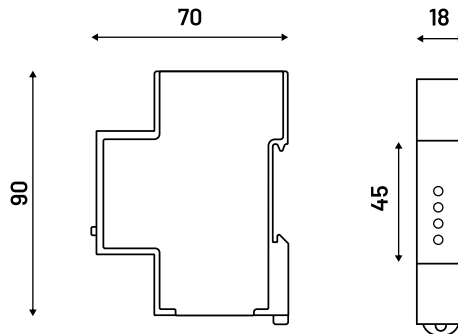

# Montaggio

(EN) Assembly - (FR) Montage

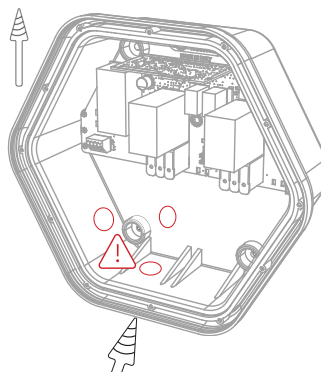
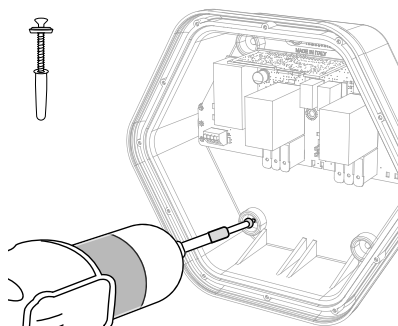
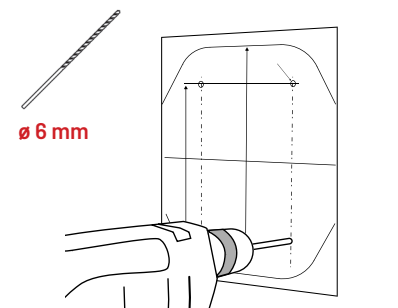

**1.**

(IT) Forare utilizzando la dima in dotazione a p. 15

(EN) Drill using the template supplied at p. 15

(FR) Percer en utilisant le modèle fourni à la p. 15

**2.**

(IT) Mettere tasselli e avvitare Prism al muro.

(EN) Put dowels and screw Prism to the wall.

(FR) Poser des chevilles et visser Prism au mur.



(IT) Grado IP di Prism garantito solo con viti e rondelle forniti o equivalenti.

(EN) The IP rating of prism guaranteed only with screws and washers supplied or equivalent.

(FR) L'indice de protection IP de Prism n'est garanti qu'avec les vis et les rondelles fournies ou équivalentes.

**3.**

(IT) Forare per ingresso cavi.\*

(EN) Drill for cable entry.\*

(FR) Percer pour l'entrée du câble.\*



(IT) \*Non forare Prism in punti differenti da quelli indicati nel presente manuale. La foratura in punti differenti da quelli indicati comporta il decadimento della garanzia.

(EN) \*Do not drill Prism in points other than those indicated in this manual. Drilling in points other than those indicated will invalidate the guarantee.

(FR) \*Ne pas percer Prism à d'autres endroits que ceux indiqués dans ce manuel. Le fait de percer à des endroits autres que ceux indiqués annule la garantie.



≥ IP55\*

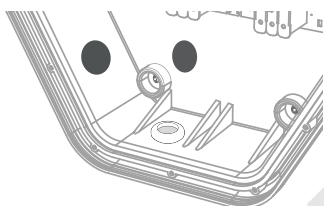

**4.**

**(IT)** Passare cavi e mettere pressacavo.

**(EN)** Pass the cables and put the cable gland.

**(FR)** Passer les câbles et placer le presse-étoupe.



**(IT)** \*Utilizzare pressacavi adeguati al grado IP di Prism.

**(EN)** \*Use cable glands suitable for the IP rating of the Prism.

**(FR)** \*Utiliser des presse-étoupes adaptés à l'indice IP de Prism.

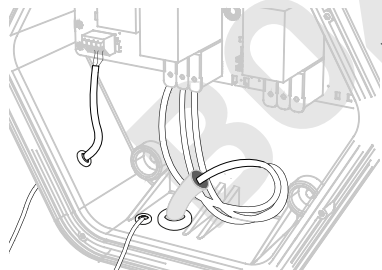

**5.**

**(IT)** Collegare i cavi (p. 11, p. 13).

**(EN)** Connect the cables (p. 11, p. 13).

**(FR)** Connecter les câbles (p. 11, p. 13).

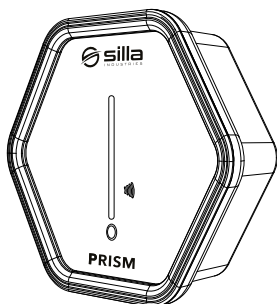

**6.**

**(IT)** Chiudere (p. 19).

**(EN)** Close (p. 19).

**(FR)** Fermer (p. 19).



# Installazione Prism Solar

(EN) Prism Solar installation - (FR) Installation de Prism Solar

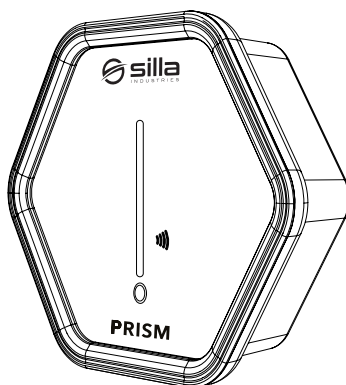

## Prism Solar Monofase

(EN) Prism Solar single-phase - (FR) Prism Solar Monophasé

### ► Cablaggio alimentazione

(EN) Power wiring - (FR) Câblage d'alimentation

#### A. Monofase

(EN) Single phase  
(FR) Monophasé

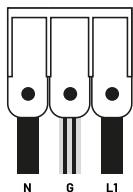

#### B. Bifase

(EN) Two-phase  
(FR) Biphasé

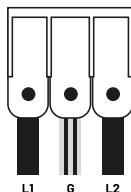

(IT) Prism Solar monofase NON può essere installata su impianto trifase. Il bilanciamento dei carichi non funzionerà.

(EN) Prism Solar single phase CANNOT be installed on a three-phase system. Load balancing will not work.

(FR) Le Prism Solar monophasé NE PEUT PAS être installé sur un système triphasé. L'équilibrage de la charge ne fonctionnera pas.

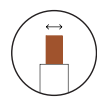

max. 10 mm<sup>2</sup>



max. 6 mm<sup>2</sup>



(IT) Assicurarsi che la tensione in ingresso non ecceda il limite di 230 V AC Monofase o 400V AC Trifase (+/- 10%).

(EN) Make sure that the voltage never exceeds 230 V AC Single-phase or 400V AC Three-phase (+/- 10%).

(FR) S'assurer que la tension ne dépasse jamais 230 V CA monophasé ou 400 V CA triphasé (+/- 10 %).



### ► Cablaggio del Sensore

(EN) Sensor Wiring - (FR) Câblage du Capteur

(IT) Il sensore è richiesto per il bilanciamento dei carichi. Seguire le indicazioni per il corretto funzionamento.

(EN) The sensor is required for load balancing. Follow the instructions for correct operation.

(FR) Le capteur est nécessaire pour l'équilibrage de la charge. Suivez les instructions pour un fonctionnement correct.

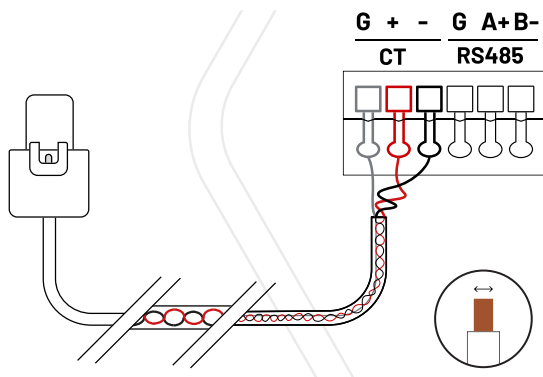

L < 100m CAT5

(IT) Utilizzabile CAT5 per lunghezze contenute

(EN) Useable CAT5 for short distances

(FR) CAT5 utilisable pour les faibles longueurs

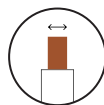

0.25-0.5 mm<sup>2</sup>

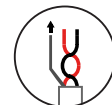

(IT) Usare un doppino intrecciato e schermato

(EN) Use a shielded twisted pair

(FR) Utiliser une paire torsadée et blindée



## ► Collocazione del Sensore in Monofase

**(EN)** Positioning of the Sensor in Single Phase - **(FR)** Positionnement du Capteur en Monophasé

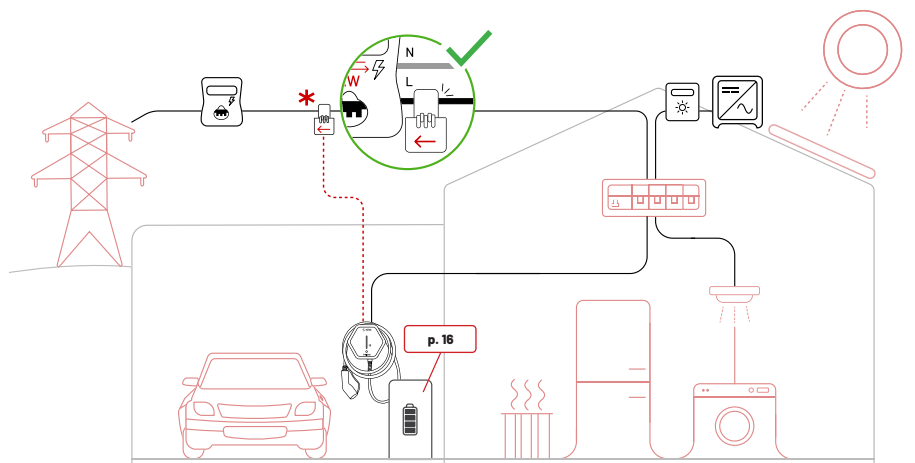

**(IT)** \*Per funzionare correttamente il sensore deve misurare tutta la potenza in entrata e uscita dal contatore generale, compresa quella di Prism e di un eventuale impianto solare. Se non installato correttamente il bilanciamento dei carichi non funzionerà.

**(EN)** \*For the sensor to function properly, it must measure all the power entering and leaving the general electricity meter, including that of prism and any possible solar plants. If it is not installed correctly, load balancing will not work.

**(FR)** \*Pour fonctionner correctement, le capteur doit mesurer toute la puissance entrant et sortant du compteur d'énergie général y compris celle de Prism et d'une éventuelle centrale solaire. S'il n'est pas installé correctement, l'équilibrage des charges ne fonctionnera pas.

## ► Errori comuni

**(EN)** Common mistakes - **(FR)** Erreurs fréquentes

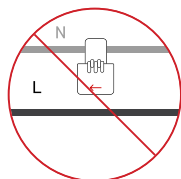

**(IT)** No sul neutro  
**(EN)** Not on neutral  
**(FR)** Pas sur le neutre

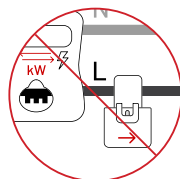

**(IT)** No verso sbagliato  
**(EN)** No wrong way  
**(FR)** Pas de mauvaise voie

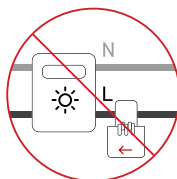

**(IT)** No sul contatore fotovoltaico  
**(EN)** No on the photovoltaic meter  
**(FR)** Pas sur le compteur photovoltaïque

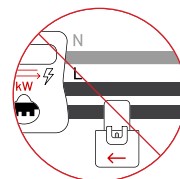

**(IT)** Non includere tutti i cavi  
**(EN)** Not include any cables  
**(FR)** Aucun câble n'est inclus

# Prism Solar Trifase

(EN) Prism Solar Three-phase - (FR) Prism Solar Triphasé

## ► Cablaggio alimentazione

(EN) Power wiring - (FR) Câblage d'alimentation

### A. Trifase

(EN) Three-phase  
(FR) Triphasé

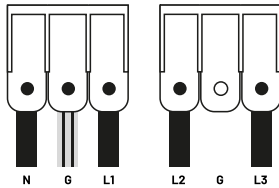

### B. Monofase

(EN) Single phase  
(FR) Monophasé

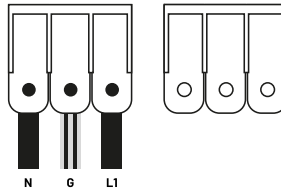

### C. Bifase

(EN) Two-phase  
(FR) Biphasé

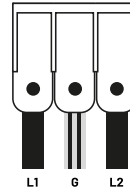

max. 10 mm<sup>2</sup>



max. 6 mm<sup>2</sup>

(IT) Alcune auto caricano utilizzando una sola fase. Si consiglia di collegare su L1 la fase dell'impianto meno impegnata, in modo da mitigare lo sbilanciamento creato durante la ricarica monofase.

(EN) Some cars charge using only one phase. It is advisable to connect to L1 the less busy phase of the system, thus reducing the imbalance created during single phase charging.

(FR) Certaines voitures se recharge en utilisant une seule phase. Il est recommandé de brancher sur L1 la phase de l'installation la moins engagée, afin d'atténuer le déséquilibre créé lors de la charge monophasée.



(IT) Assicurarsi che la tensione in ingresso non ecceda il limite di 230 V AC Monofase o 400V AC Trifase (+/- 10%).

(EN) Make sure that the voltage never exceeds 230 V AC Single-phase or 400V AC Three-phase (+/- 10%).

(FR) S'assurer que la tension ne dépasse jamais 230 V CA monophasé ou 400 V CA triphasé (+/- 10%).

## ► Collocazione dello Smart Meter

(EN) Location of the Smart Meter - (FR) Emplacement du Smart Meter

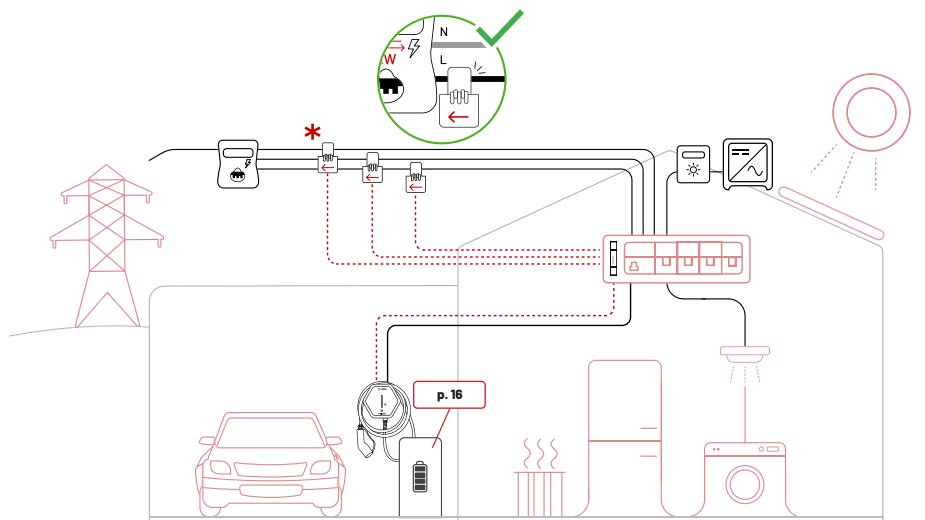

**(IT)** \* Per funzionare correttamente il sensore deve misurare tutta la potenza in entrata e uscita dal contatore generale, compresa quella di Prism e di un eventuale impianto solare. Se non installato correttamente il bilanciamento dei carichi non funzionerà.

**(EN)** \* For the sensor to function properly, it must measure all the power entering and leaving the general electricity meter, including that of prism and any possible solar plants. If not installed correctly, load balancing will not work.

**(FR)** \* Pour fonctionner correctement, le capteur doit mesurer toute la puissance entrant et sortant du compteur d'énergie général y compris celle de Prism et d'une éventuelle centrale solaire. S'il n'est pas installé correctement, l'équilibrage des charges ne fonctionnera pas.

## ► Errori comuni

(EN) Common mistakes - (FR) Erreurs fréquentes

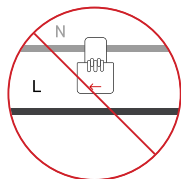

**(IT)** No sul neutro  
**(EN)** Not on neutral  
**(FR)** Pas sur le neutre

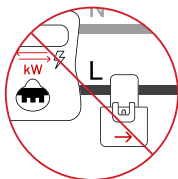

**(IT)** No verso sbagliato  
**(EN)** No wrong way  
**(FR)** Pas de mauvaise voie

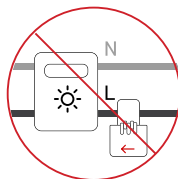

**(IT)** No sul contatore fotovoltaico  
**(EN)** No on the photovoltaic meter  
**(FR)** Pas sur le compteur photovoltaïque

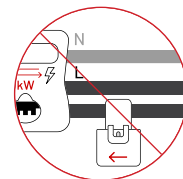

**(IT)** Non includere tutti i cavi  
**(EN)** Not include any cables  
**(FR)** Aucun câble n'est inclus



# Dima per il montaggio a parete di Prism Solar

(EN) Prism Solar wall mounting template - (FR) Gabarit de fixation murale de Prism Solar

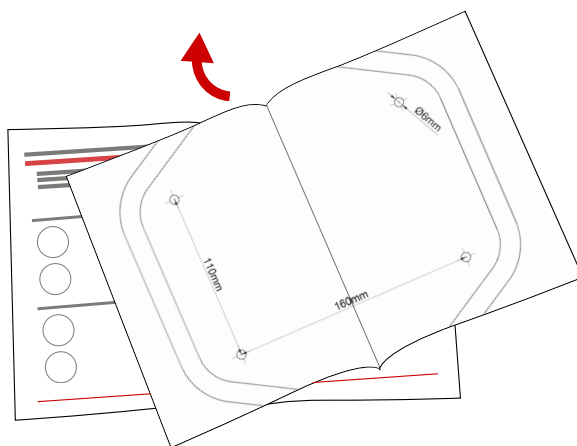

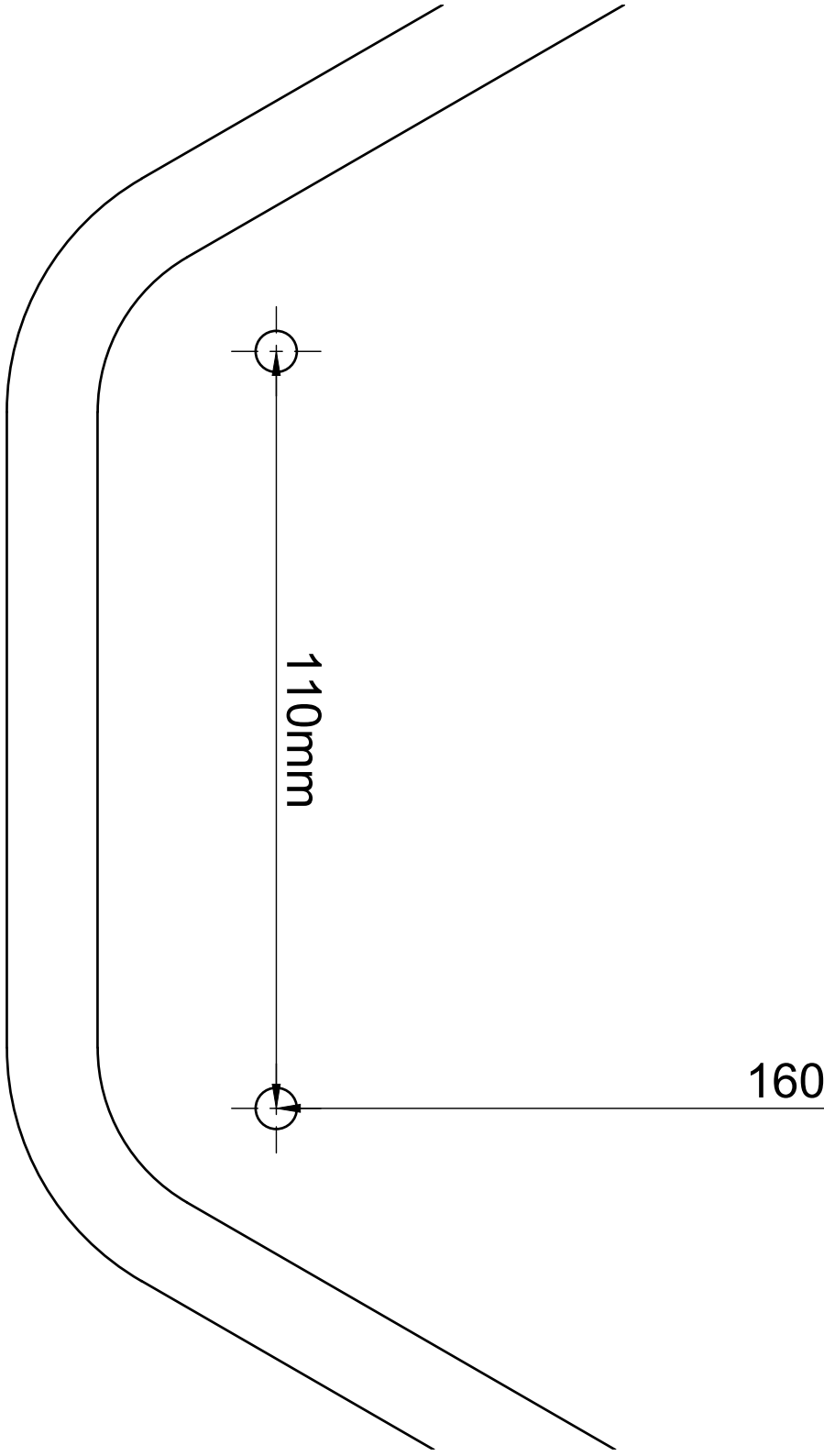

mm

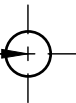
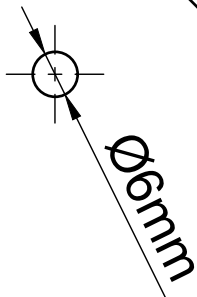



## ► Cablaggio dello Smart Meter

(EN) Connecting the Smart Meter - (FR) Câblage du Smart Meter



(IT) Assicurarsi che la tensione in ingresso non ecceda il limite di 230 V AC Monofase o 400V AC Trifase (+/- 10%).

(EN) Make sure that the voltage never exceeds 230 V AC Single-phase or 400V AC Three-phase (+/- 10%).

(FR) S'assurer que la tension entre ne dépasse jamais 230 V CA monophasé ou 400 V CA triphasé (+/- 10 %).

## ► Collegamento ad impianto Trifase

(EN) Connection to three-phase system - (FR) Connexion à un système triphasé

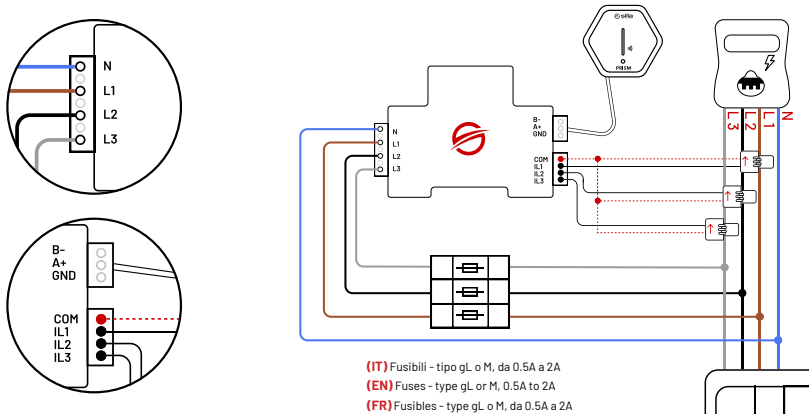

## ► Collegamento ad impianto Monofase / Bifase

(EN) Connection to single-phase / two-phase system - (FR) Connexion à un système monophasé / biphasé

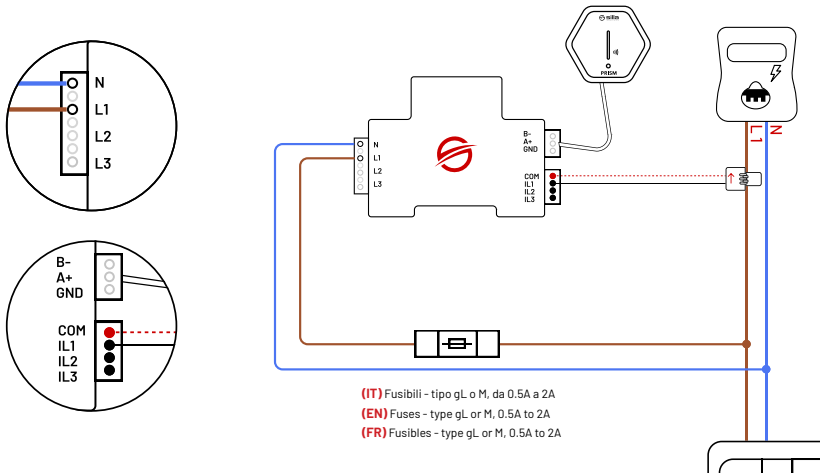

## ► Collegamento a Prism

**(EN)** Sensor connection to Prism Solar Three-phase - **(FR)** Connexion du capteur au Prism Solar Tri-phasé

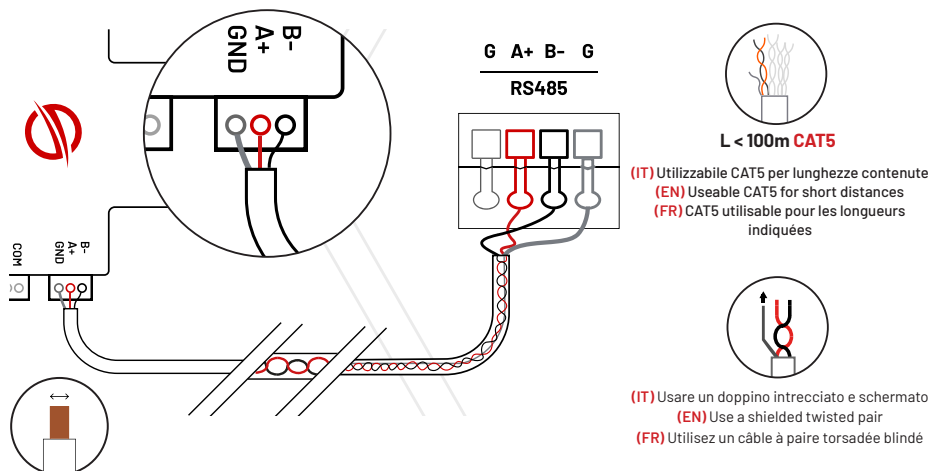

0.25-0.5 mm<sup>2</sup>

**(IT)** Smart Meter è richiesto per il bilanciamento dei carichi. Utilizzare un cavo come da indicazioni per il corretto funzionamento.

**(EN)** Smart Meter is required for load balancing. Use a cable as indicated for correct operation.

**(FR)** Un Smart Meter est requis pour l'équilibrage de la charge. Utilisez un câble comme indiqué pour assurer un fonctionnement correct.

## Impianti con sistema di accumulo

**(EN)** Systems with storage system - **(FR)** Dispositifs avec système d'accumulation

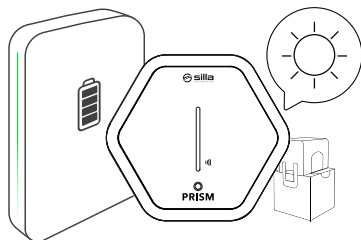

**(IT)** Prism può funzionare con qualsiasi sistema di accumulo. Prism può essere installata a monte o a valle dell'accumulo.

**(EN)** Prism can work with any storage system. Prism can be installed upstream or downstream of the storage system.

**(FR)** Prism peut fonctionner avec n'importe quel système de stockage. Prism peut être installé en amont ou en aval de la batterie de stockage.

## ► A. Collegamento a monte del sensore dell'accumulo

**(EN)** A. Connection upstream of the storage system sensor - **(FR)** A. Raccordement du capteur en amont de la batterie d'énergie solaire

**(IT)** L'impianto domestico e il sistema di accumulo avranno priorità sul consumo di energia solare rispetto a Prism.

**(EN)** The house utility and storage system will have priority on solar energy consumption over Prism.

**(FR)** L'installation de l'énergie domestique et le système de stockage de la maison auront la priorité sur la consommation d'énergie solaire par rapport à Prism.

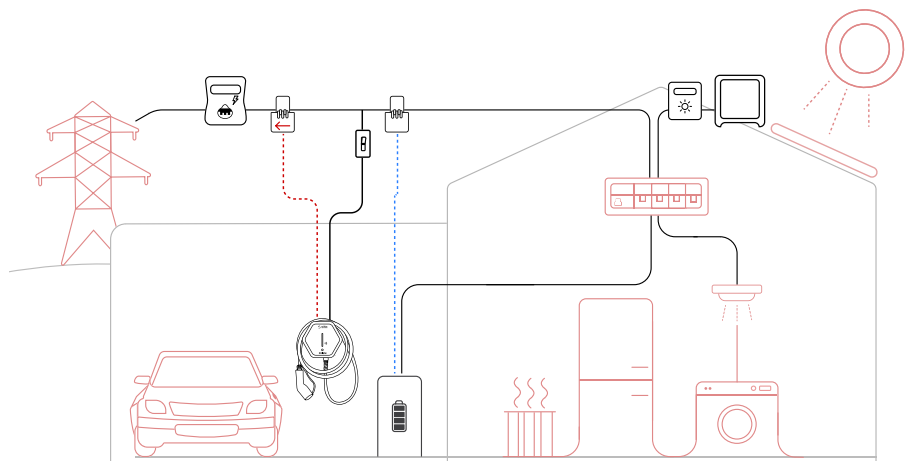

 Solar	► Normal
<p><b>(IT)</b> Prism inizierà a caricare solamente quando ci sarà energia esportata in rete. Avranno dunque precedenza i consumi dell'impianto domestico e la ricarica del sistema di accumulo, il quale esporterà energia in rete solo quando sarà completamente carico.</p> <p><b>(EN)</b> Prism will only start charging when excess energy is exported to the grid. The domestic system's consumption and the storage system's recharging take precedence, excess energy will only be exported to the grid when the storage system is fully charged.</p> <p><b>(FR)</b> Prism ne commencera à se charger que lorsque de l'énergie sera exportée vers le réseau. La consommation du système domestique et la recharge du système d'accumulation seront donc prioritaires, ce dernier n'exportant de l'énergie vers le réseau que lorsqu'il sera complètement chargé.</p>	<p><b>(IT)</b> Prism non preleverà l'energia dal sistema di accumulo, ma solo dalla rete e da eventuale produzione solare in eccesso quando il sistema di accumulo è completamente carico.</p> <p><b>(EN)</b> Prism will not draw energy from the storage system, but only from the grid and any excess solar production when the storage system is fully charged.</p> <p><b>(FR)</b> Prism ne tire pas d'énergie du système de stockage, mais uniquement du réseau et de toute production solaire excédentaire lorsque le système de stockage est entièrement chargé.</p>

## ► B. Collegamento a valle del sensore dell'accumulo

**(EN)** B. Connection downstream of the storage system sensor - **(FR)** B. Raccordement en aval du capteur en aval de la batterie d'énergie solaire

**(IT)** Prism avrà priorità sul consumo di energia solare rispetto al sistema di accumulo.

**(EN)** Prism will have priority on solar energy consumption over the storage system.

**(FR)** Prism donnera la priorité à la consommation d'énergie solaire par rapport au système de stockage.

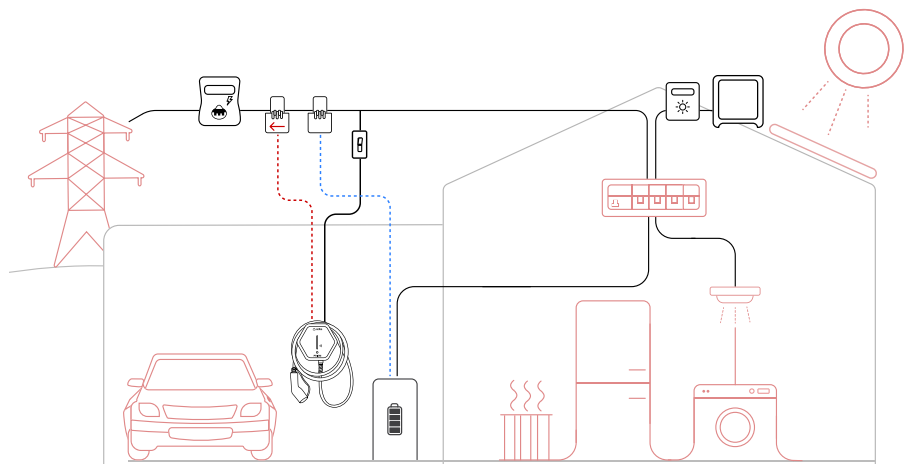

☀ Solar	► Normal
<p><b>(IT)</b> Prism inizierà a caricare immediatamente e caricherà fin quando ci sarà energia disponibile dal fotovoltaico e dal sistema di accumulo. In caso di interruzione della ricarica, questa riprenderà solamente quando ci sarà esportazione di energia verso la rete.</p> <p><b>(EN)</b> Prism will start charging immediately and continue to charge as long as excess energy is available from the PV and storage system. If charging is interrupted, it will only resume when excess energy is again exported to the grid.</p> <p><b>(FR)</b> Prism commencera à se charger immédiatement et se chargera tant qu'il y aura de l'énergie disponible provenant du système photovoltaïque et du système de stockage. Si la charge est interrompue, elle ne reprendra que lorsque l'énergie sera exportée vers le réseau.</p>	<p><b>(IT)</b> Prism preleverà l'energia dal sistema di accumulo e dall'impianto fotovoltaico, prelevando anche dalla rete in caso di potenza insufficiente dal sistema di accumulo.</p> <p><b>(EN)</b> Prism will draw energy from the storage system and the photovoltaic system, and from the grid in case of insufficient power from the storage system.</p> <p><b>(FR)</b> Prism tirera de l'énergie du système de stockage et du système photovoltaïque, ainsi que du réseau en cas d'insuffisance de puissance du système de stockage.</p>



## Bobina di sgancio

(EN) Release coil - (FR) Bobine de déclenchement

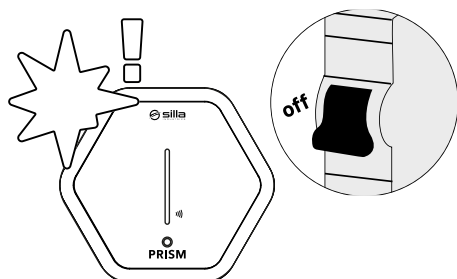

(IT) Prism può essere collegata ad una bobina di sgancio esterna che intervenga in caso di guasto dei relè di Prism. Ove sia necessaria l'installazione di una bobina di sgancio è necessario contattare Silla per ricevere l'accessorio MODSGA01 che facilita il collegamento della bobina di sgancio a Prism.

(EN) Prism can be connected to an external release coil that intervenes in case of failure of Prism's relays. If installation of a release coil is required, you should contact Silla to order the MODSGA01 accessory that facilitates the connection of a release coil to Prism.

(FR) Prism peut être connecté à une bobine de déclenchement externe qui intervient en cas de défaillance des relais Prism. Si l'installation d'une bobine de déclenchement est nécessaire, il est nécessaire de contacter Silla pour commander l'accessoire MODSGA01 qui facilite la connexion d'une bobine de déclenchement à Prism.

## Completare l'installazione

(EN) Complete the installation - (FR) Terminer l'installation

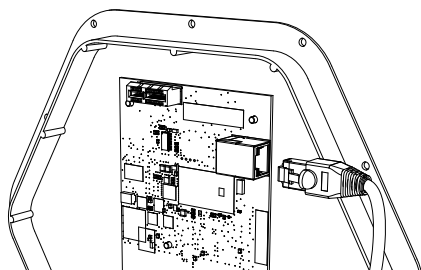

(IT) Collegare cavo Ethernet (opzionale).

(EN) Connect Ethernet cable (optional).

(FR) Connecter le Câble Ethernet (optionnel).

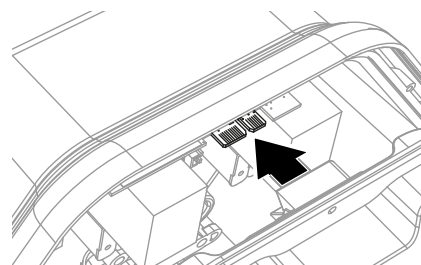

(IT) Fare attenzione che il connettore presente sulla cover vada ad incastrarsi correttamente sul pettine dorato presente sulla scheda di base.

(EN) Ensure that the connector on the cover fits correctly onto the golden connector on the baseboard.

(FR) Veillez à ce que le connecteur du couvercle s'insère correctement dans le connecteur doré de la carte de base.

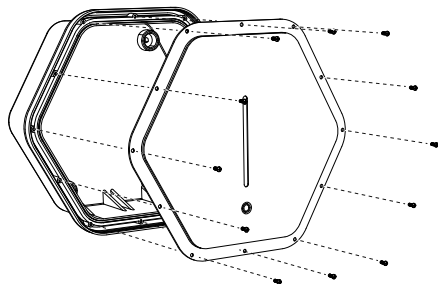

**(IT)** Avvitare le 12 viti in dotazione in corrispondenza dei relativi fori.

**(EN)** Screw the 12 screws supplied into the relative holes.

**(FR)** Visser les 12 vis fournies dans les trous correspondants.

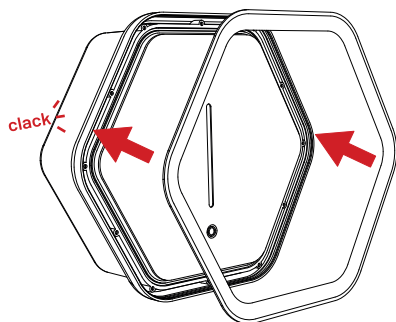

**(IT)** Installare la cornice a incastro e rimuovere la pellicola protettiva della cover.

**(EN)** Install the snap frame and remove the protective film from the cover.

**(FR)** Installez le cadre d'encliquetage et retirez le film protecteur du couvercle.

## Configurazione guidata

(EN) Wizard setup - (FR) Assistant de configuration

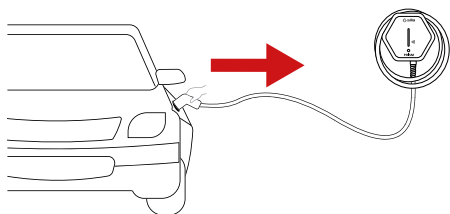

(IT) Prima di procedere, scollegare il connettore di Prism dall'auto.

(EN) Before proceeding, unplug the Prism connector from the car.

(FR) Avant de procéder, débranchez le connecteur Prism de la voiture.

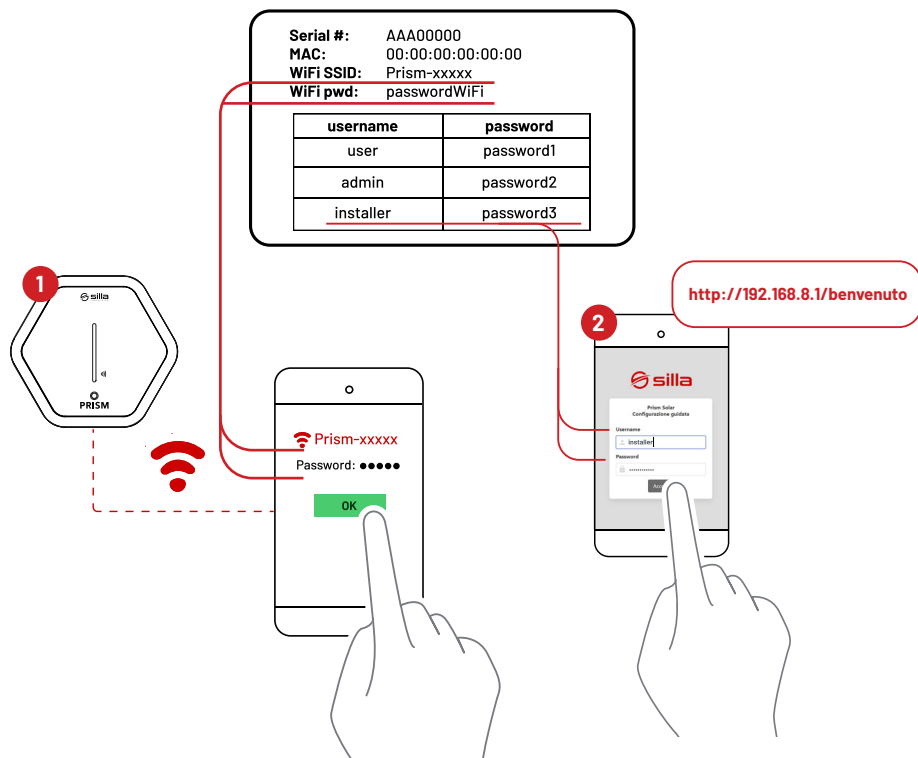

1

(IT) Collegati alla rete WiFi di Prism

(EN) Connect to Prism's WiFi network

(FR) Connectez-vous au réseau WiFi de Prism

2

(IT) Fai login e segui la configurazione guidata

(EN) Log in and follow the setup wizard

(FR) Connectez-vous et suivez l'assistant de configuration



## Primo utilizzo

(EN) First use - (FR) Première utilisation

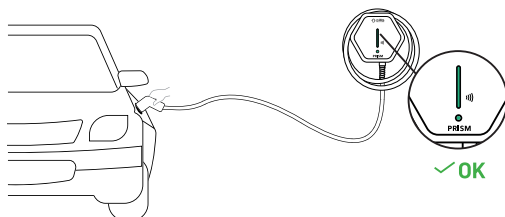

### ► Errori

(EN) Errors - (FR) Erreurs

<p><b>(IT)</b> Stacca il connettore da Prism, attendi 3 secondi e inseriscilo nuovamente.</p> <p><b>(EN)</b> Unplug the connector from Prism, wait 3 seconds, and thread it again.</p> <p><b>(FR)</b> Débranchez le connecteur de Prism, attendez 3 secondes et enfillez-le à nouveau.</p>	<p><b>(IT)</b> Spegni Prism e contatta l'assistenza. Vedi p. 24</p> <p><b>(EN)</b> Turn off Prism and contact assistance. See p. 24</p> <p><b>(FR)</b> Éteignez Prism et contactez l'assistance. Voir p. 24</p>	<p><b>(IT)</b> Vai sul manuale online per maggiori informazioni. Vedi p. 24</p> <p><b>(EN)</b> Check the online manual for further information. See p. 24</p> <p><b>(FR)</b> Reportez-vous au manuel en ligne pour plus d'informations. Voir p. 24</p>

## Funzionalità

(EN) Functionality - (FR) Fonctionnalité

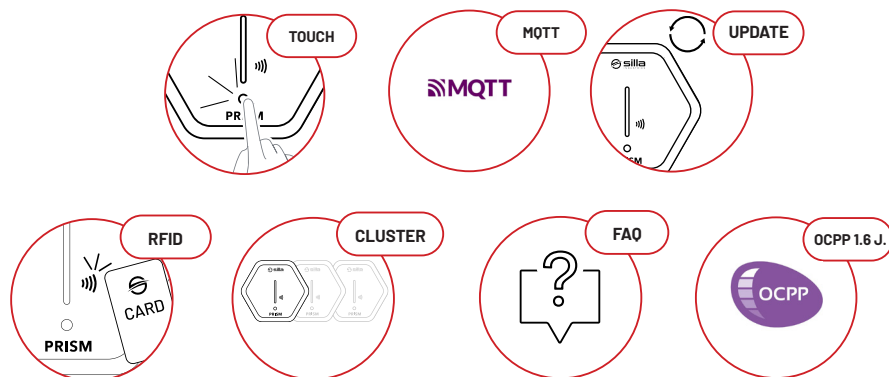

► My Silla Cloud

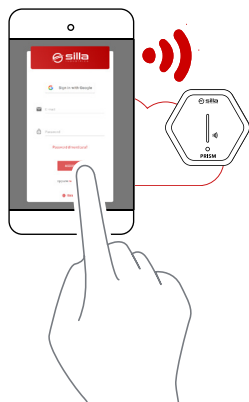

**(IT)** Registrati su **MySilla** per controllare Prism da remoto (necessaria connessione internet).

**(EN)** Register on **MySilla** to control Prism remotely (internet connection required).

**(FR)** S'inscrire sur **MySilla** pour contrôler Prism à distance (connexion internet requise).



<https://my.silla.cloud/>

► Reset

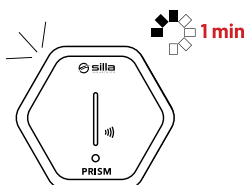
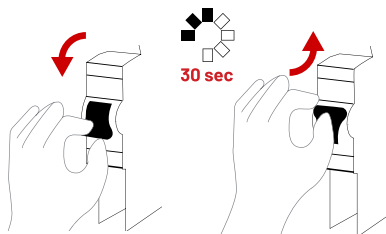
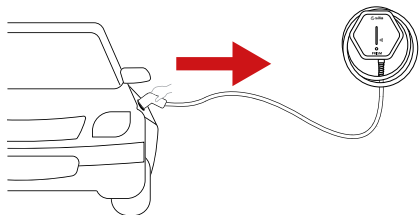

**(IT)** Prima di procedere, scollegare il connettore di Prism dall'auto.

**(EN)** Before proceeding, unplug the Prism connector from the car.

**(FR)** Avant de procéder, débranchez le connecteur Prism de la voiture.

**(IT)** Spegner Prism dal sezionatore a monte ed attendere almeno 30 secondi.

**(EN)** Turn off Prism from the upstream disconnector and wait at least 30 seconds.

**(FR)** Éteindre Prism à partir du déconnecteur en amont et attendre au moins 30 secondes.

**(IT)** Riaccendere Prism ed attendere circa 1 minuto.

**(EN)** Turn Prism back on and wait for about 1 minute.

**(FR)** Remettre Prism sous tension et attendre environ 1 minute.

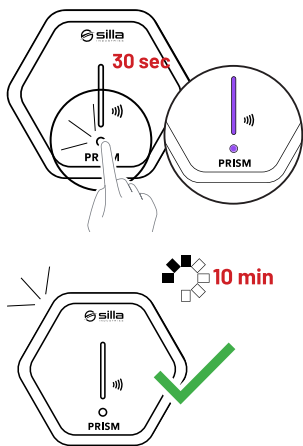

**(IT)** Entro 5 minuti, tenere premuto il pulsante touch di Prism per 30 secondi. Prism accenderà i LED di colore viola.

**(EN)** Within 5 minutes, press and hold the touch button of Prism for 30 seconds. Prism will turn the LEDs purple.

**(FR)** Dans les 5 minutes qui suivent, appuyez sur le bouton tactile de Prism et maintenez-le enfoncé pendant 30 secondes. Prism rendra les LED violettes.

**(IT)** Attendere almeno 10 minuti senza spegnere Prism. Le impostazioni sono ripristinate. Vai a p. 4.

**(EN)** Please wait at least 10 minutes without turning off Prism. The settings are will then be restored. Proceed to p. 4.

**(FR)** Attendez au moins 10 minutes sans éteindre Prism. Les paramètres sont rétablis. Aller à la p. 4.

### ► Pulizia periodica

**(EN)** Periodic cleaning - **(FR)** Pulizia periodica

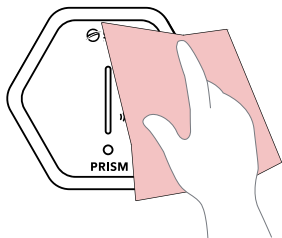

**(IT)** Scollegare il dispositivo dalla sua alimentazione prima di effettuare qualunque operazione di pulizia o manutenzione.

**(EN)** Unplug the device from its power supply before carrying out any cleaning or maintenance operation.

**(FR)** Débranchez l'appareil de son alimentation électrique avant toute opération de nettoyage ou d'entretien.

## Assistenza clienti

**(EN)** Customer service - **(FR)** Nettoyage périodique



**T:** +39 049 232 5440 - ext.2

**Email:** support@silla.industries

<https://silla.industries/>

<https://silla.industries/docs/>



## Garanzia

**(EN)** Warranty - **(FR)** Garantie

**(IT)** Le norme di garanzia hanno valore soltanto se il dispositivo viene impiegato nelle condizioni d'uso previste.

I termini di garanzia sono disponibili online a <https://silla.industries/docs>

**In caso di necessità di utilizzo della garanzia, contattare:**

**Silla Industries**

**Email:** support@silla.industries

**Telefono:** +39 049 2325440

**(EN)** The warranty provisions are only valid if the device is used under the intended conditions of use.

The full warranty terms are available online at <https://silla.industries/docs>

**If you need to use the warranty, please contact:**

**Silla Industries**

**Email:** support@silla.industries

**Telephone:** +39 049 2325440

**(FR)** Les dispositions de la garantie ne sont valables que si l'appareil est utilisé dans les conditions d'utilisation prévues.

Les conditions de garantie sont disponibles en ligne à l'adresse suivante : <https://silla.industries/docs>

**Si vous avez besoin d'utiliser la garantie, veuillez contacter:**

**Silla Industries**

**E-mail :** support@silla.industries

**Telephone :** +39 049 2325440



<https://silla.industries/docs/>

## Caratteristiche tecniche

**(EN)** Technical features - **(FR)** Caractéristiques techniques

### CARATTERISTICHE TECNICHE

Connessione	AC, connessione permanente alla rete elettrica
Input/Output (monofase)	AC 230 V 32 A max @ 25°C
Input/Output (trifase)	AC 400 V 32 A max @ 25°C
Condizioni ambientali	Range di temperatura di utilizzo: da -25°C a +55°C Range di temp. di stoccaggio: da -30°C a +60°C Umidità relativa: max. 100% a 25°C Adatto ad uso interno ed esterno
Accesso alla ricarica	Sia pubblico che privato
Montaggio	Montaggio superficiale a muro, pali o posizioni equivalenti
Classe sicurezza elettrica	Classe I
Grado di protezione	IP65 - IK10
Modo di ricarica	Modo 3
Dispositivi di protezione	RCD 6mA DC / 30mA AC
Ventilazione	Non supportata
Altitudine	≤ 2000 m

### TECHNICAL FEATURES

Connection	AC, permanent connection to mains
Input/Output (single-phase)	AC 230 V 32 A max @ 25°C
Input/Output (three-phase)	AC 400 V 32 A max @ 25°C
Environmental conditions	Operating temperature: -25 °C to +55 °C Storage temperature: -30 °C to +60 °C Relative humidity: max. 100% at 25°C Suitable for: internal and external
Charging access	Both public and private
Mounting	Surface mount to wall, post, or equivalent location
Electrical safety class	Class I
Degree of protection	IP65 - IK10
Charging mode	Mode 3
Protection devices	RCD 6mA DC / 30mA AC
Ventilation	Not supported
Altitude	≤ 2000 m

### CARACTÉRISTIQUES TECHNIQUES

Alimentation	AC, Connecté en permanence au réseau
Input/Output (monophase)	AC 230 V 32 A max @ 25°C
Input/Output (triphase)	AC 400 V 32 A max @ 25°C
Conditions environnementales	Température de fonctionnement: -25°C à +55 °C Température de stockage: -30 °C à +60°C Humidité relative max. 100% sur 25°C Convient à: une utilisation interne et externe
Accès à la charge	Public et privé
Installation	Fixation en surface sur un mur, un poteau ou un emplacement équivalent
Classe de sécurité électrique	Classe I
Degré de protection	IP65 - IK10
Mode de charge	Mode 3
Dispositifs de protection	RCD 6mA DC / 30mA AC
Ventilation	Non prise en charge
Altitude	≤ 2000 m

## Dichiarazione di conformità UE

**(EN)** EU Declaration of Conformity - **(FR)** Déclaration de Conformité de l'UE

**(IT)** Dichiarazione di conformità UE semplificata

Il fabbricante, Silla Srl, dichiara che il tipo di apparecchiatura radio Prism Solar è conforme alla direttiva 2014/53/UE. Il testo completo della dichiarazione di conformità UE è disponibile al seguente indirizzo internet: <https://silla.industries/prism-solar-s-EU-Doc>

**(EN)** Simplified EU Declaration of Conformity

The manufacturer, Silla Srl, declares that the radio equipment type Prism Solar complies with Directive 2014/53/EU. The full text of the EU Declaration of Conformity is available at the following internet address: <https://silla.industries/prism-solar-s-EU-Doc>

**(FR)** Déclaration de conformité simplifiée de l'UE

Le fabricant, Silla Srl, déclare que l'équipement radio de type Prism Solar est conforme à la directive 2014/53/UE. Le texte intégral de la déclaration de conformité de l'UE est disponible à l'adresse internet suivante: <https://silla.industries/prism-solar-s-EU-Doc>



<https://silla.industries/docs/>















Via della Meccanica, 2/A  
35127 Padova - PD  
Italia

<https://silla.industries>  
[support@silla.industries](mailto:support@silla.industries)  
+39 049 2325440